

## Water-bearing fireplaces type A. / front door

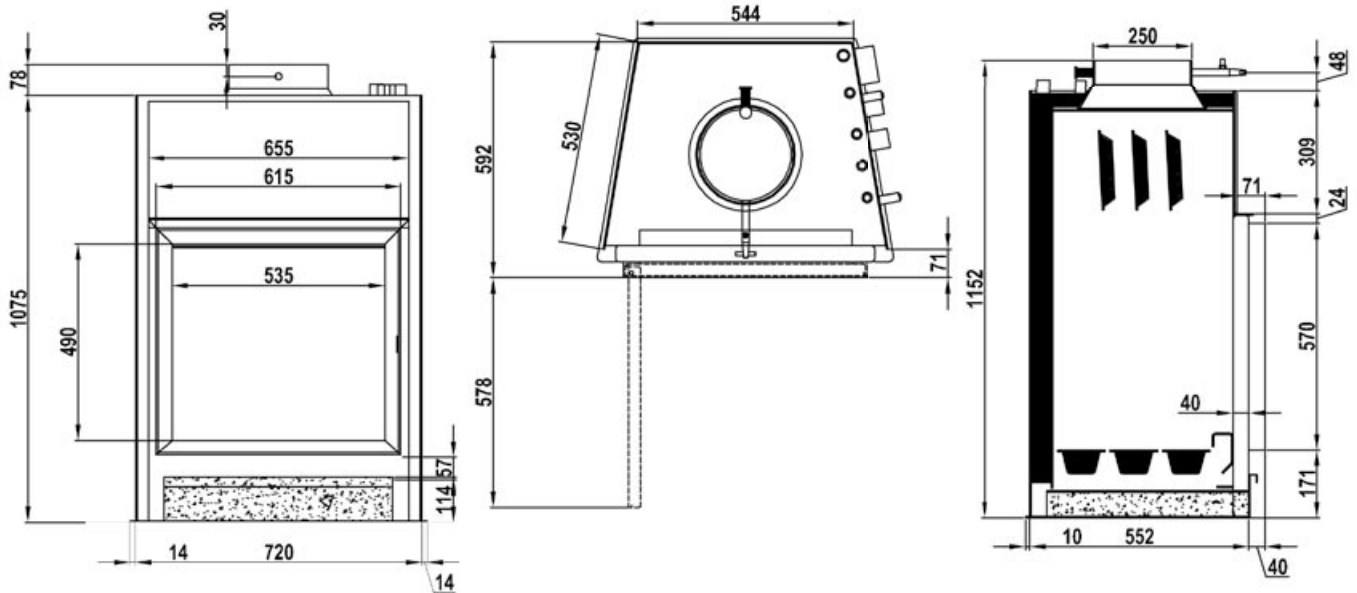

## Water-bearing fireplaces type B. / prism- / oriel door

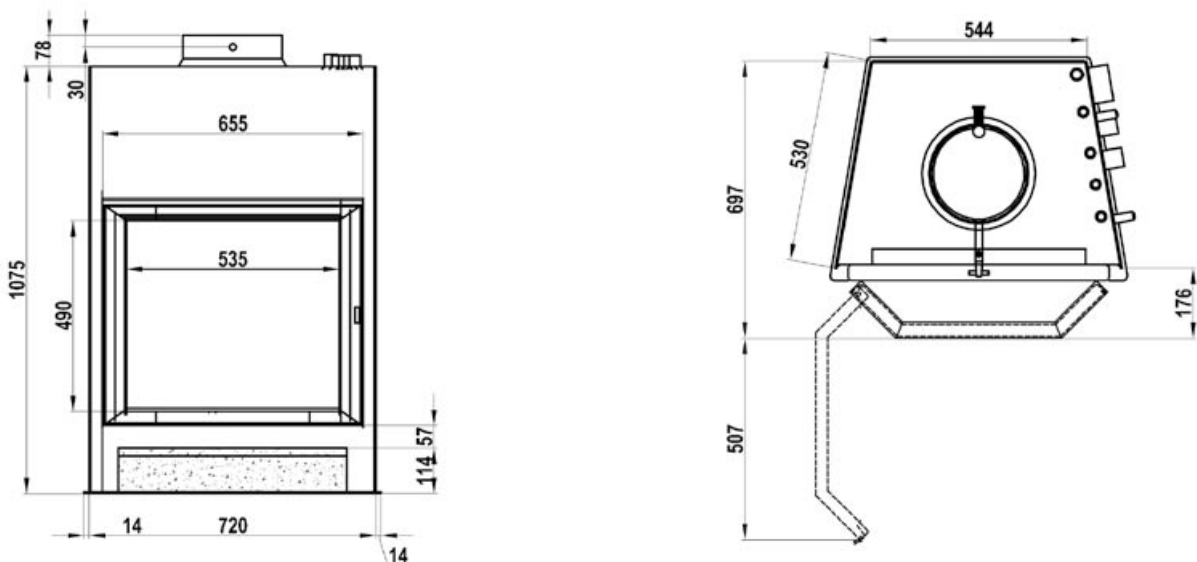

All fireplace boilers are delivered with adjustable feet at a value of 230 mm - 300 mm. (M24)  
The indicated technical dimensions are subject to tolerances caused by production.  
General German build-up-obvious permission with the number Z-43.11-195.

A product of Normatherm Stahlheizkesselbau Germany.



## Water-bearing fireplaces type C. / round bending door

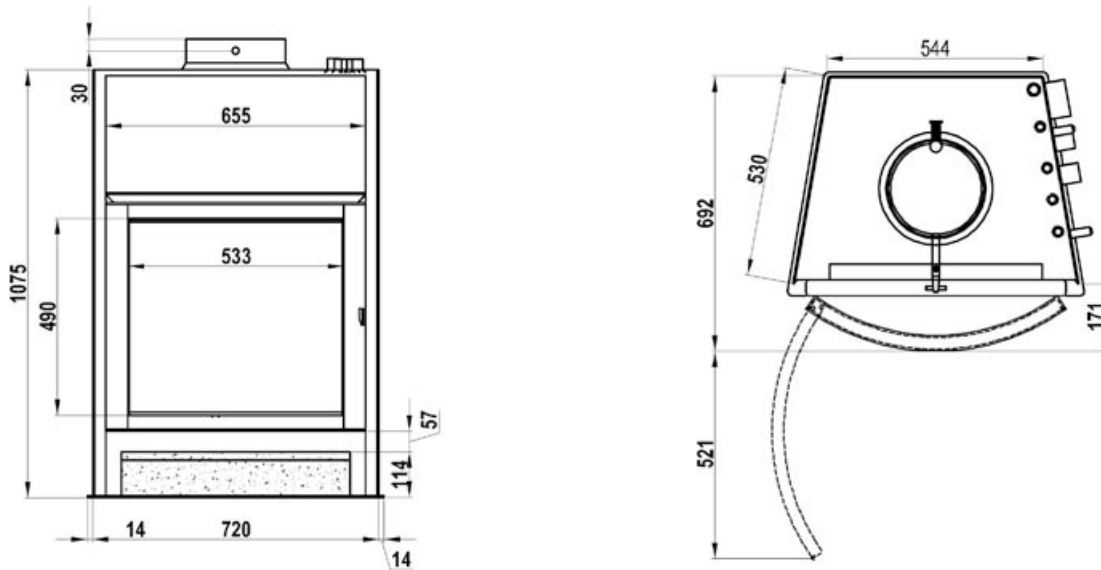

## Water-bearing fireplaces type D. / raisable door

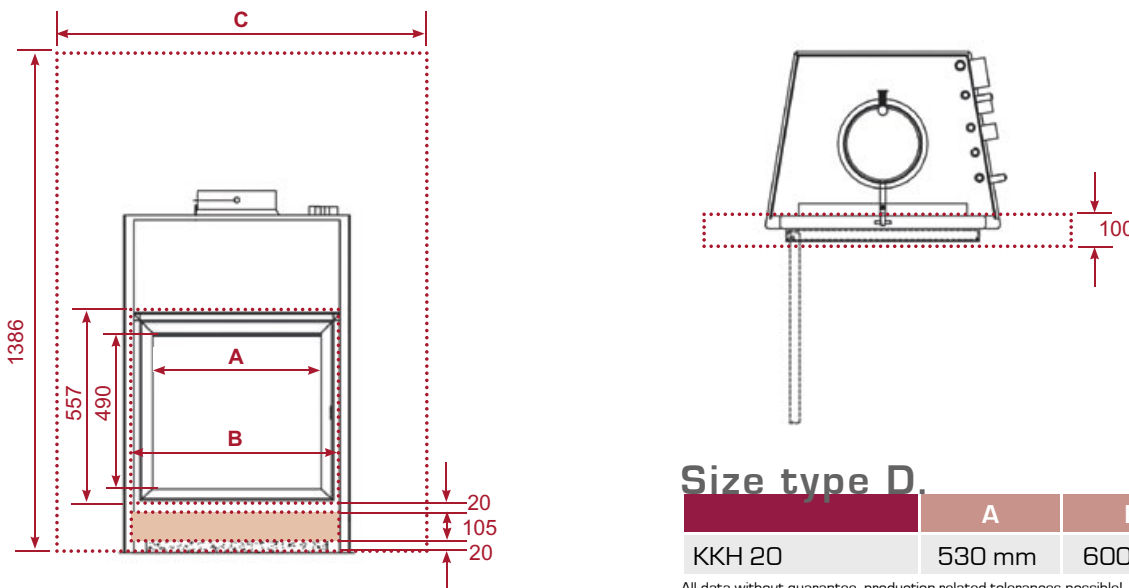

### Size type D.

	A	B	C
KKH 20	530 mm	600 mm	900 mm

All data without guarantee, production-related tolerances possible!

## Water-bearing chimney inserts

Type							
	KKH 15	KKH 20	KKH 25	KKH 30	KKH 40	KKH 45	
	15 kW	20 kW	25 kW	30 kW	40 kW	45 kW	
Rated output with coal, water-sided	kW	18	21	23	30	38	42
Rated output with wood, water-sided	kW	14,4	17,3	21,4	26,7	36,6	41,8
Radiating power, wood, closed	kW	1,2	1,9	3,3	2,7	3,8	4,0
Watervolume	Liter	120	130	140	150	220	245
Heating surface	m <sup>2</sup>	2,25	2,58	2,68	3,46	3,95	4,73
Weight chimney insert, not packed	kg	145	160	180	210	250	290
Wood length (max.)	cm	40	50	50	70	80	80