

Data sheet KKH 40 with round front door

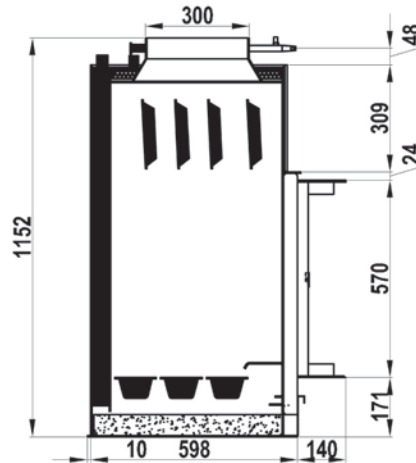
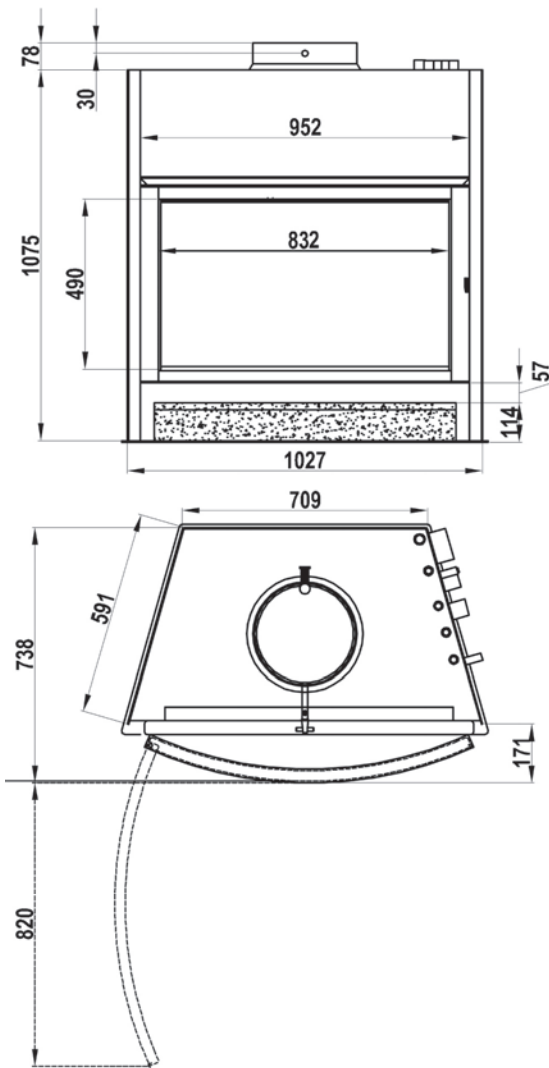

All fire-place boilers are delivered with adjustable feet at a value of 230 mm - 300 mm. (M24)

The indicated technical dimensions are subject to tolerances caused by production.

General German build-up-obvious permission with the number Z-43.11-195.



A product of Normatherm Stahlheizkesselbau Germany.

Water-bearing chimney inserts

Type	British thermal units						
	KKH 15	KKH 20	KKH 25	KKH 30	KKH 40	KKH 45	
	52 BTU	68 BTU	85 BTU	102 BTU	136 BTU	152 BTU	
Rated output with coal, water-sided	BTU	61	71	78	102	129	143
Rated output with wood, water-sided	BTU	49,1	58,9	72,9	91,0	124,7	142,5
Radiating power, wood, closed	BTU	4,1	6,5	11,2	6,8	12,9	13,6
Watervolume	Liter	120	130	140	150	220	245
Heating surface	sq ft	24,2	27,7	28,8	37,4	42,5	50,9
weight chimney insert, not packed	lb	319,6	352,7	396,8	462,9	551,1	639,3